



Adenovirus PRO24-186 System



Table of Contents

| | |
|--|----|
| Preface | ii |
| Contact Information..... | ii |
| About VIQUA – a Trojan Technologies Business | ii |
| Scope | ii |
| 1.0 Project & System Description..... | 1 |
| 1.1 Project Description..... | 1 |
| 1.2 System Description | 1 |
| 2.0 Product Drawings..... | 2 |
| 2.1 Install Diagram..... | 2 |
| 2.2 Mounting Diagram..... | 3 |
| 2.3 Flow Meter Installation Options | 3 |
| 2.4 Exploded View..... | 4 |
| 3.0 System Overview | 5 |
| 3.1 4-Log Virus Reduction..... | 5 |
| 3.2 Pressure Drop..... | 5 |
| 3.3 UV Dose Monitoring | 6 |
| 3.3.1 Dose Curve..... | 6 |
| 3.3.2 Dose Alarm Selection | 7 |
| 3.3.3 UV Sensor..... | 8 |
| 3.3.4 Sensor Response Curve..... | 9 |
| 3.3.5 Flow Meter..... | 9 |
| 3.3.6 Controller Interface..... | 10 |
| 3.3.7 COMMcenter™ | 10 |
| 3.4 UV Lamp | 11 |
| 3.4.1 Mercury Discharge Lamp Spectral Output | 11 |
| 3.4.2 Degradation Chart | 12 |
| 3.4.3 Temperature Profile | 12 |
| 3.4.4 Quartz Sleeve | 13 |
| 3.5 Product Features and Benefits..... | 13 |
| 3.5.1 LightWise™ Technology..... | 13 |
| 3.6 Signals and Remote Capabilities..... | 14 |
| 3.6.1 Dry Contacts | 14 |
| 3.6.2 4-20 mA Interface | 14 |
| 4.0 Certifications..... | 14 |
| 5.0 Warranty | 15 |
| VIQUA Quality Principals..... | 16 |

PREFACE

Contact Information

425 Clair Road West
Guelph, Ontario, Canada, N1L 1R1
Tel: 519-763-1032
Fax: 519-763-5069
info@viqua.com
www.viqua.com

About VIQUA – a Trojan Technologies Business

We believe clean water is an invaluable resource. That's why, for more than a quarter of a century, we have led the development of water treatment solutions using environmentally friendly ultraviolet (UV) light. Today, VIQUA has the largest install base of UV systems in operation on the planet, and many of our innovations define the industry standards for safeguarding our water from the damaging effects of microbial contamination.

From offices and facilities in eight countries, the 800 employees of Trojan are united by an unwavering commitment to deliver advanced water treatment solutions that make water safety a reality worldwide.

VIQUA is an ISO9001:2008 registered company specializing in the design, manufacture, and sale of ultraviolet systems for:

- household drinking water
- light commercial drinking water
- point-of-use treatment
- point-of-entry treatment

VIQUA has over 600,000 systems installed worldwide, and VIQUA systems can be found in almost every country in the world. Applications of VIQUA systems, beyond the basic residential and light commercial uses, include rain water harvesting, ground water treatment, disaster relief, humanitarian aid, medical devices, and bottled-water refill stations.

Scope

This document highlights the features and specifications of the validated Adenovirus PRO24-186 system, capable of 186mJ/cm² dose at 24 gpm to achieve 4-log virus reduction. This system is ideal for regulated residential and light commercial applications.

1.0 PROJECT & SYSTEM DESCRIPTION

1.1 Project Description

| Project Name | Guidelines |
|---------------------|--------------------------------------|
| Maximum flow rate | 24 GPM (91 l/min) at 95% UVT |
| Design dose | 186 mJ/cm ² |
| Operating pressure | 15 psi (103 kPa) - 125 psi (862 kPa) |
| Ambient air temp. | 0°C (32°F) - 40°C (104°F) |
| Ambient water temp. | 1°C (35.6°F) - 45°C (104°F) |
| Hardness | 120 ppm (7 grains / gallon) max.* |
| Manganese content | 0.05 ppm max.* |
| Iron content | 0.3 ppm max.* |
| UVT | 75% min.* |

*after pretreatment

1.2 System Description

| | |
|-----------------------------|----------------------------|
| Model | PRO24-186 |
| Quantity | |
| Chamber | |
| Material | 316L SST |
| Dimensions | 41" x 4" (103 x 10 cm) |
| Inlet & outlet ports | Combo 1-1/4" MNPT, 1" FNPT |
| UL Certified burst pressure | 300 psi (2,067 kPa) |
| Orientation | Vertical |
| Electrical | |
| Power Supply | 13" x 6.5" (33 x 16.5 cm) |
| Voltage | 100 - 240 V AC |
| Frequency | 50 - 60 Hz |
| Max. current | 5 Amps |
| Max. power consumption | 460 Watts |
| Lamp power | 400 Watts |

| Spare Parts | Quantity |
|-----------------|----------|
| Lamps | |
| Sleeves | |
| UV sensors | |
| Flow Meters | |
| CoolTouch™ Fans | |
| COMMcenters™ | |

| Optional Accessories | Quantity |
|----------------------|----------|
| Solenoid valve | |
| 4-20 mA Interface | |

2.0 PRODUCT DRAWINGS

2.1 Install Diagram

The following diagram is the recommended installation layout; however, other installation set-ups are possible, including a mirrored layout to the one featured here. Chambers must be installed vertically and right side up, according to the indicators on the chambers. Ensure there is room above the chambers for lamp removal.

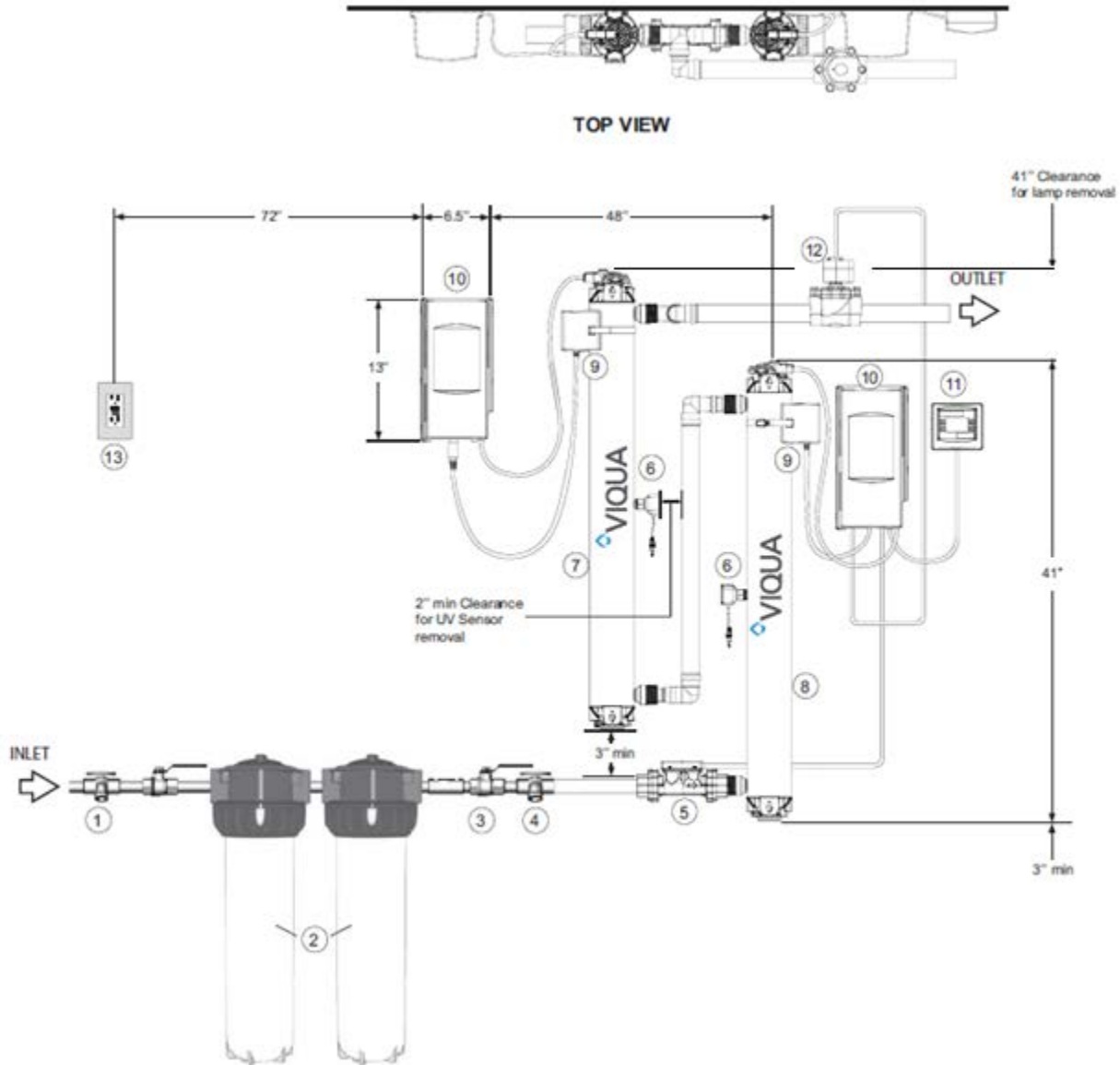

| | | | | | |
|----|----------------------|----|--------------------|----|----------------|
| 1 | Sample Valve | 2 | Pre-treatment | 3 | Shu-off Valve |
| 4 | Sample Valve | 5 | Flow Sensor | 6 | UV Sensor (2) |
| 7 | Secondary UV Chamber | 8 | Primary UV Chamber | 9 | CoolTouch™ Fan |
| 10 | Controller (2) | 11 | COMMcenter™ | 12 | Solenoid Valve |
| 13 | Power Source | | | | |

2.2 Mounting Diagram

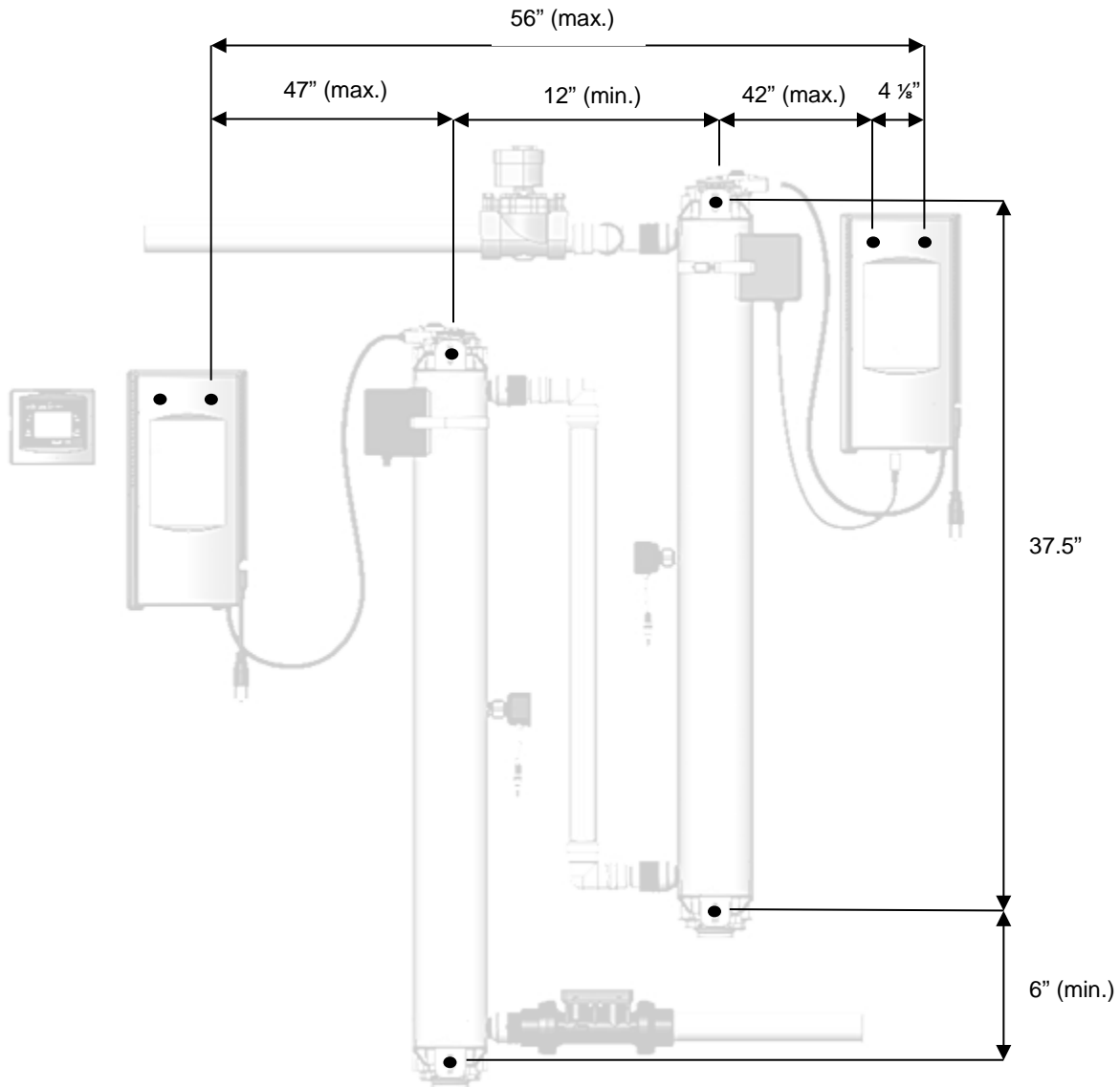

2.3 Flow Meter Installation Options

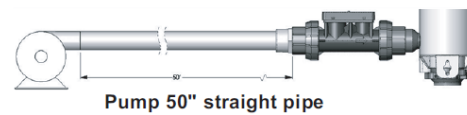
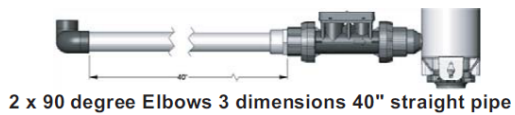
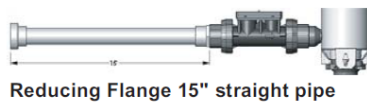
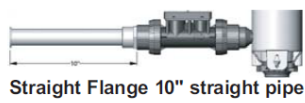

Note: Flow Meter Sensor must be mounted in the following orientation with the LED facing up. Ensure all air is purged from the piping and Flow Meter Sensor. All straight length to the Flow Meter Sensor must be 1.00" in diameter.

2.4 Exploded View

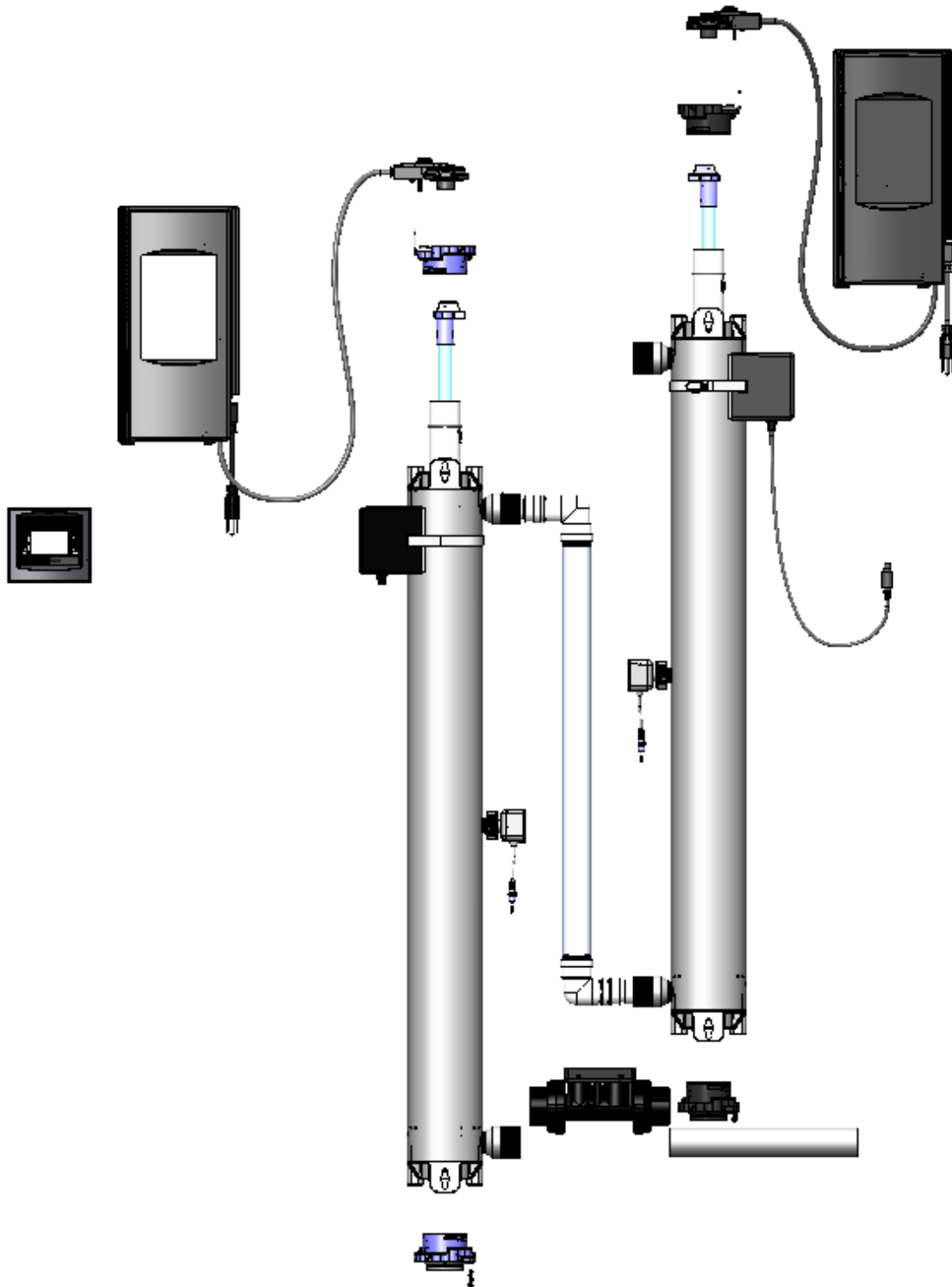

Refer to .pdf and .step files for engineering drawings and part numbers.

3.0 SYSTEM OVERVIEW

3.1 4-Log Virus Reduction

The PRO24-186 system provides over 186 mJ/cm² UV dose for 4-log reduction of viruses, including the Adenovirus. The system consists of two chambers in series utilizing amalgam UV lamps, CoolTouch™, and LightWise™ technology. The Adenovirus system is fully third-party validated to USEPA UV Disinfection Guidance Manual (UVDGM) protocol for 4-log Adenovirus reduction. In addition to the virus reduction, each of the chambers has been validated to provide 4-log reduction of Cryptosporidium and Giardia.

Benefits

- Ultra-high output amalgam lamp technology allows for compact installation.
- Intense disinfection dose reduces or removes the need for chemical treatment.
- Real-time UV intensity and flow rate sensor activate visual and audible controller alarm.

3.2 Pressure Drop

The pressure drop across the system is proportional to the flow through the system.

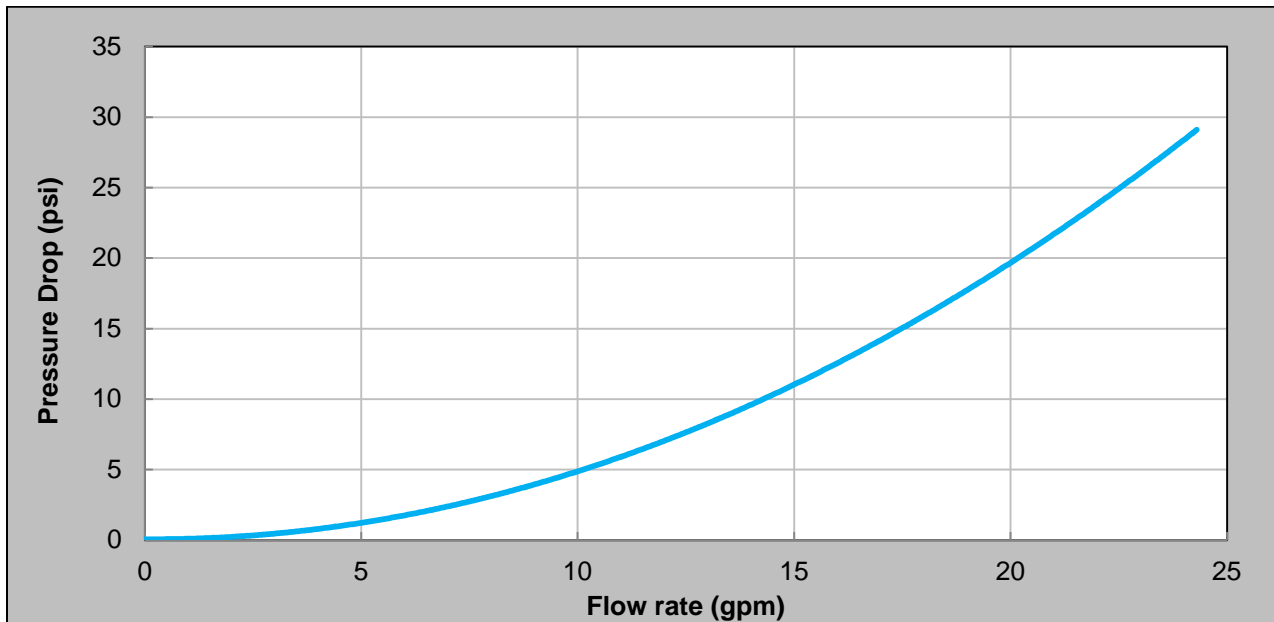

3.3 UV Dose Monitoring

3.3.1 Dose Curve

Dose values such as those in the following graph are calculated based on third-party verified bioassay testing completed in compliance with the 2006 UVDGM.

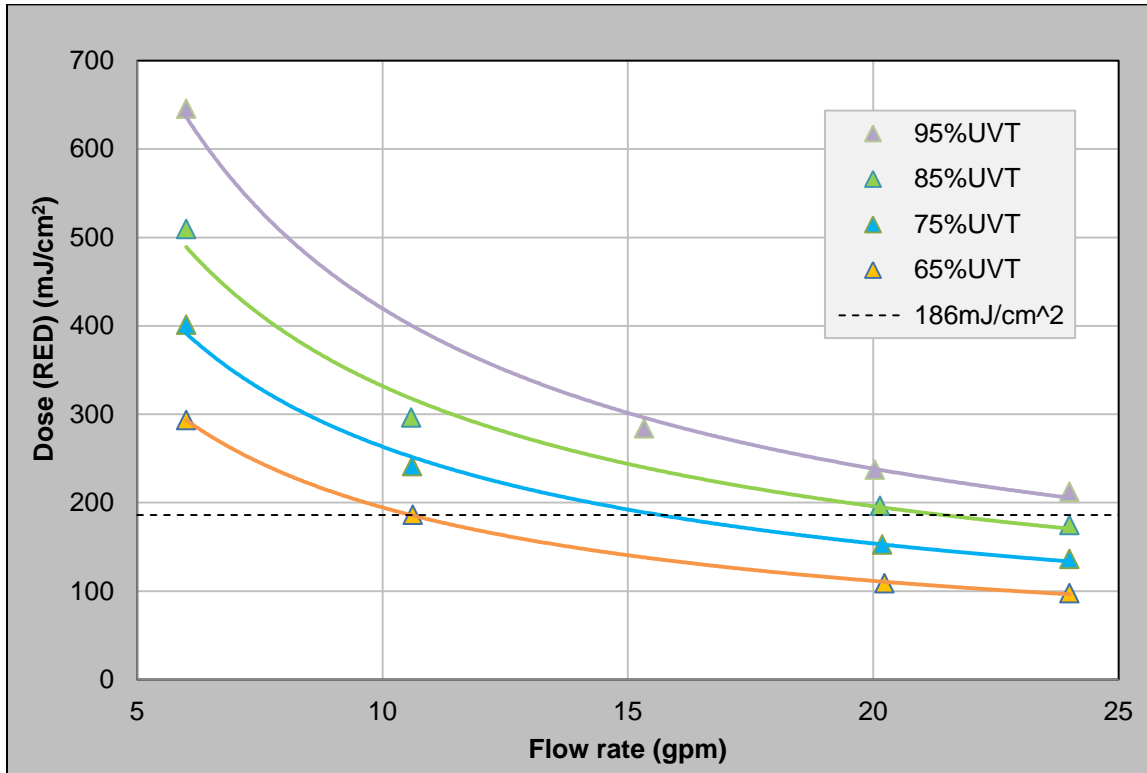

There is no flow restrictor on the Adenovirus system. Therefore, the system can physically exceed 24 GPM; however, at flow rates above 24 GPM the system will go into alarm and the solenoid valve, if connected, will cut off the flow of water.

3.3.2 Dose Alarm Selection

VIQUA's Adenovirus system comes equipped with real-time UV dose monitoring which utilizes data from both the UV sensor (3.3.3) and the flow meter (3.3.5). The system will go into alarm at different points depending on input from these components. There are two dose settings to choose from: variable or stepped dose alarm. The system will come factory set as variable but may be set to stepped depending on regional regulations.

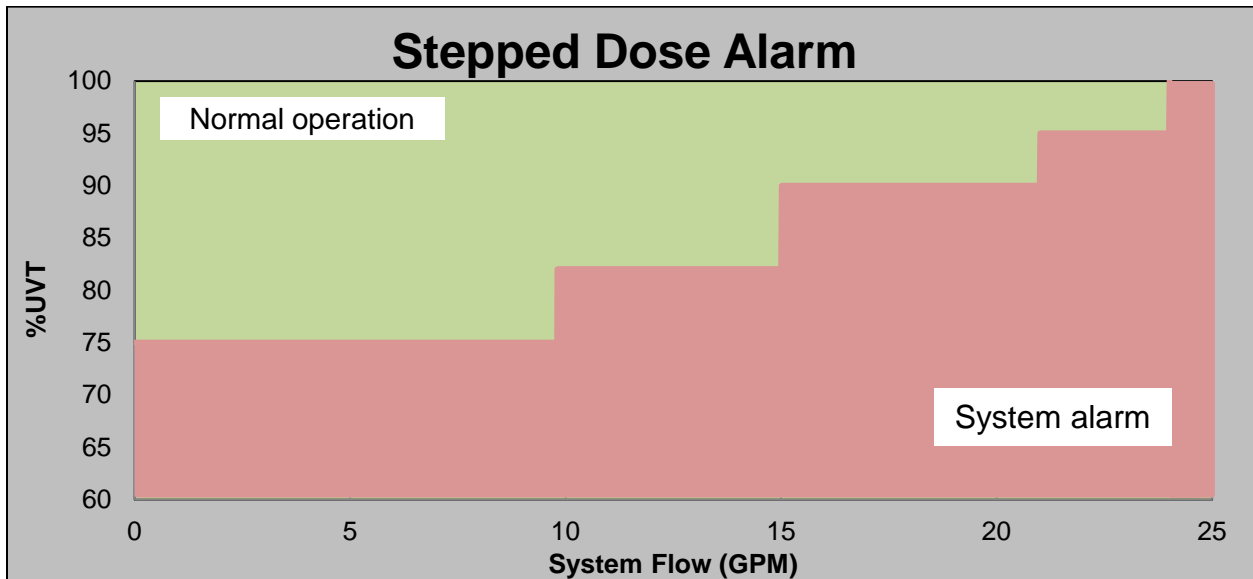
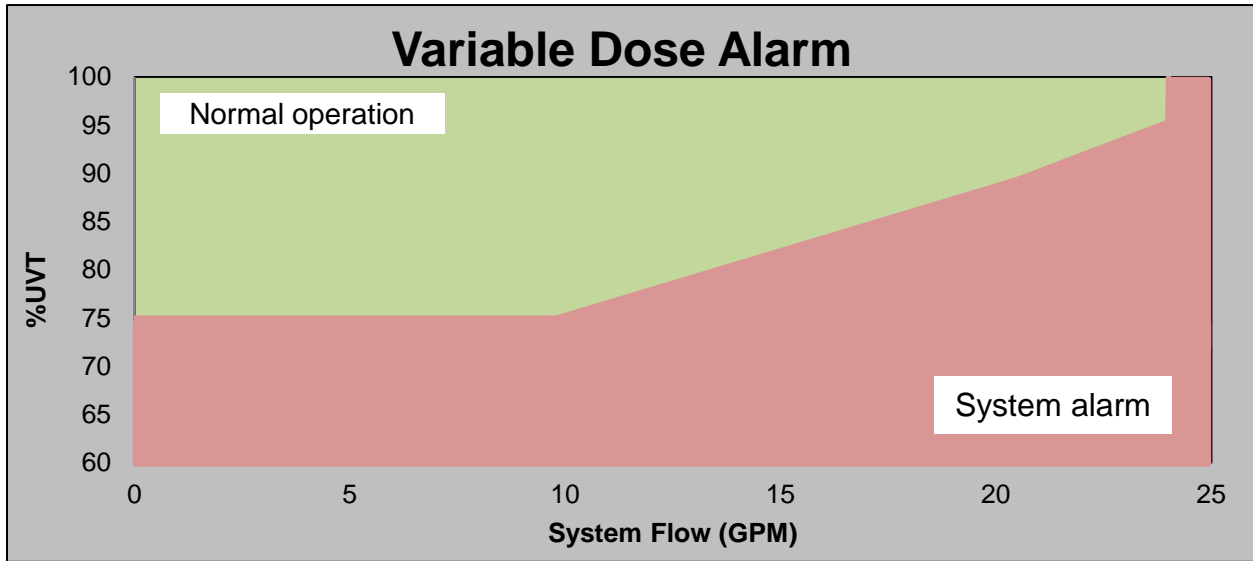

The corresponding alarm set points for the Stepped Dose Alarm are given in the table below.

| Flow Range | Required minimum sensor output | Approximate UVT |
|---------------|--------------------------------|-----------------|
| 0 - 9.9 gpm | 11.7 mA | 75% |
| 10 - 14.9 gpm | 13.1 mA | 82% |
| 15 - 20.9 gpm | 14.7 mA | 90% |
| 21 - 24 gpm | 15.8 mA | 95% |

3.3.3 UV Sensor

Many factors influence a system's level of UV disinfection, including water quality (primarily UVT), lamp output, and quartz sleeve fouling. Rather than basing set-points on any one of these factors, alarm set-points are based on the quantity of light that actually reaches the sensor. In this way, the UV sensor detects when the water flowing furthest away from the lamp is no longer being disinfected properly due to any factor. VIQUA's UV sensors reliably detect low UV output and identify the need for maintenance via a 4-20 mA output signal to the controller.

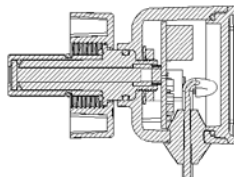

Features

- Factory assembled and calibrated.
- UV monitored by a silicon carbide photodiode for long term stability.

3.3.4 Sensor Response Curve

The sensor's photodiode detects the emitted germicidal 253.7 nm wavelength.

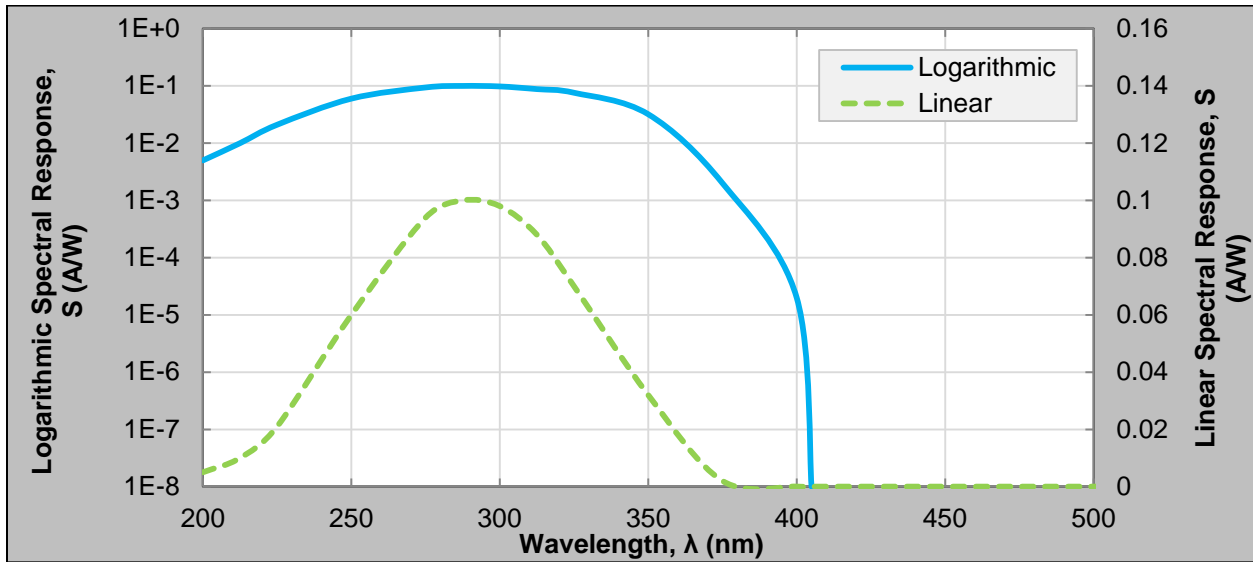

3.3.5 Flow Meter

The Adenovirus system uses a single flow meter located on the primary unit to measure the flow rate of water passing through the UV systems. The flow meter utilizes a paddle wheel and a flow detect arm to ensure reliable measurements. The flow meter outputs a 4-20 mA signal to the controller.

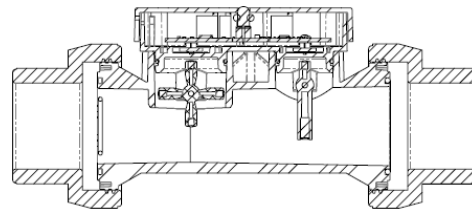

3.3.6 Controller Interface

Each controller is equipped with the following features:

1. Audible alarm
2. Audible alarm mute
3. Replacement lamp counter reset
4. Lamp operation indicator
5. Controller operation indicator
6. Solenoid valve operation indicator
7. Fan operation indicator
8. Sensor reading indicator
9. Flow meter operation indicator

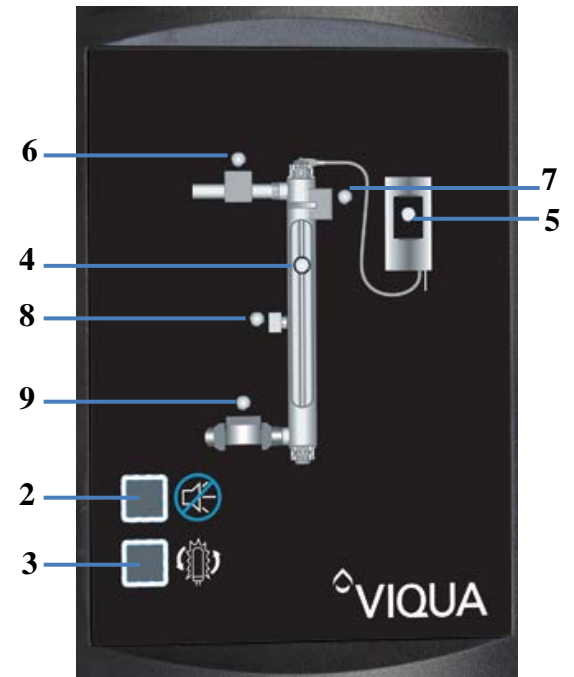

Firmware in the controllers monitors flow rate and sensor input for set point conditions. Controllers will enter audible and visual alarm if the sensor input is too low given the measured flow rate. Set points depend on the Dose Alarm Selection (sec. 3.3.2). The controller's alarm conditions act independently of the COMMcenter™ (sec. 3.3.7); though the Adenovirus PRO24-186 should always be operated with the COMMcenter™, this means the UV disinfection dose is monitored even if the COMMcenter™ should fail.

To achieve 186 mJ/cm² both systems must be on and working properly. Should one controller lose communication with the other, or if the COMMcenter™ loses communication with either controller, the system will go into visual and audible alarm.

Features

- Continuously monitors and controls the system.
- Communicates minor and major audible alarms when conditions fall outside the USEPA UVDGM prescribed operating range.
- Auto-ranging (Operates with any input voltage between 100 and 240 V).
- Constant Current.

3.3.7 COMMcenter™

The COMMcenter™ provides live monitoring, records performance, and allows for communication between the two controllers. It is connected to the primary unit on the Adenovirus system. When a Mini-SD card is inserted into the system, information is recorded every minute. A 512 MB Mini-SD card should store 18 years' worth of



information. Without the Mini-SD, the COMMcenter™ will store the last 40 alarms that have occurred.

Features

- Displays real-time dose measurements for individual units and the combined dose.
- Notifies alarm situations and provides help screens to overcome the problem.
- Archives past performance, water quality changes, power failures, alarms, and lamp age.
- RJ45 Ethernet cable connection between COMMcenter™ and controller.
- 8 GB Micro-SD card and Mini-SD adapter kit (270302-R) sold separately.

3.4 UV Lamp

3.4.1 Mercury Discharge Lamp Spectral Output

The lamp produces germicidal ultraviolet light (UV-C) at a wavelength of 253.7 nm. The absence of a peak at 185 nm is significant because it means no harmful ozone will be produced. VIQUA's amalgam lamps have a mercury content of less than 15 mg (IMERC registered).

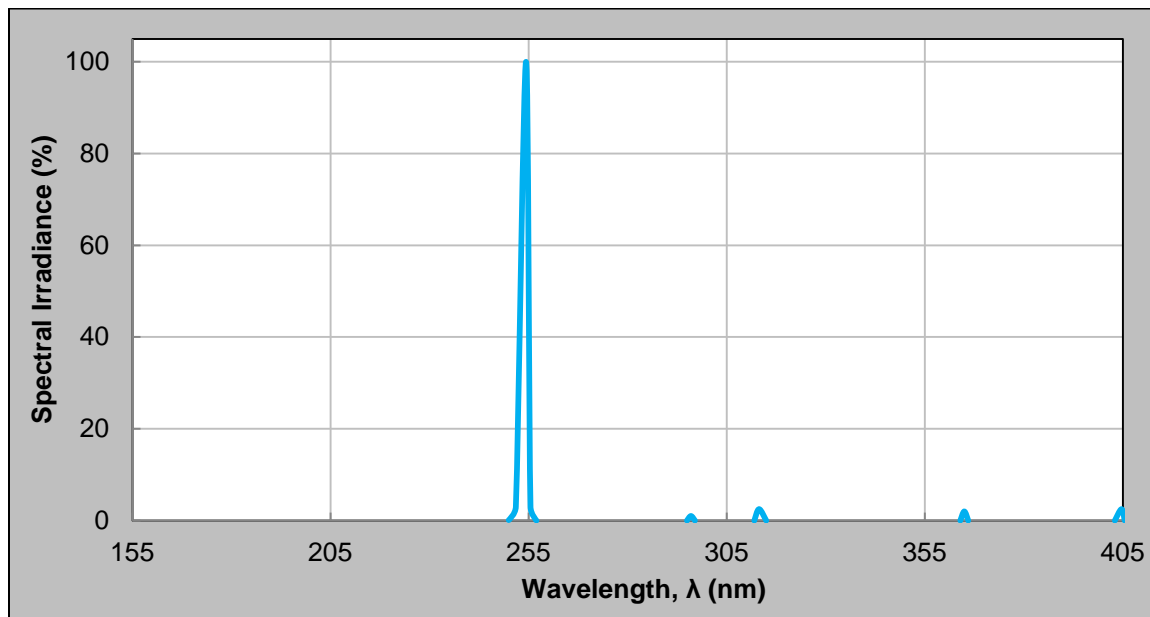

VIQUA's amalgam lamps use a mercury amalgam matrix as opposed to mercury in its pure liquid form. Therefore, the mercury is contained as a secure, solid segment. Additionally, this segment is trapped in a compartment at the bottom of the lamp.

In the case of a broken lamp, this compartment would contain the mercury. Even if this compartment also broke open, the quartz sleeve



prevents the mercury from coming in contact with water.

Features

- All electrical connections made at one end of the lamp.
- Lamp base features a diabolic barrier which prevents arcing between pins.

3.4.2 Degradation Chart

Amalgam lamps have a useful life of approximately 18,000 hours. They can provide adequate disinfection for up to two years and then require replacement.

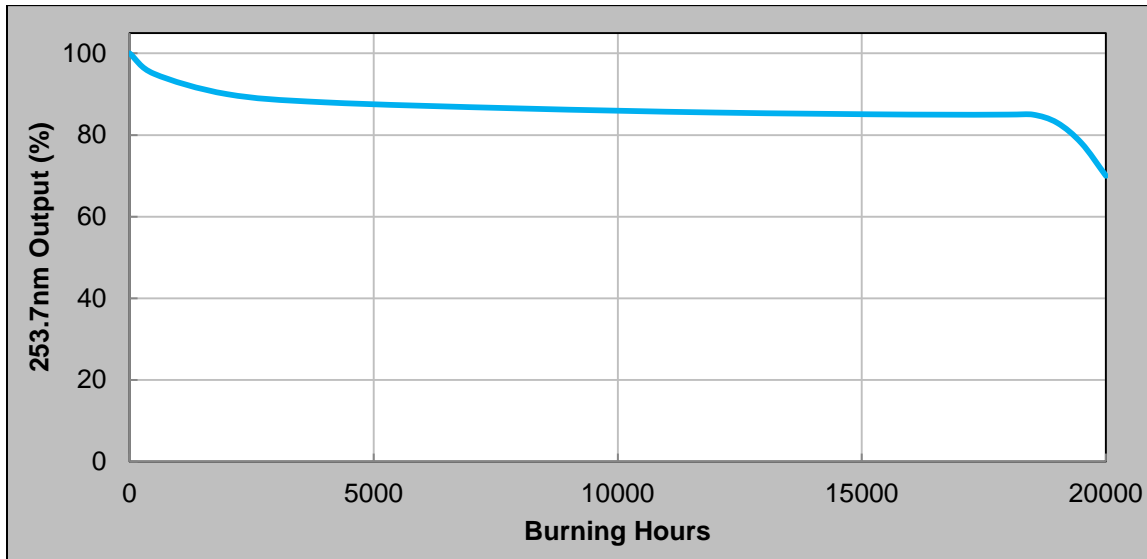

3.4.3 Temperature Profile

VIQUA's lamps use a mercury amalgam mix to control the vapour pressure and produce a more stable output than conventional standard output lamps.

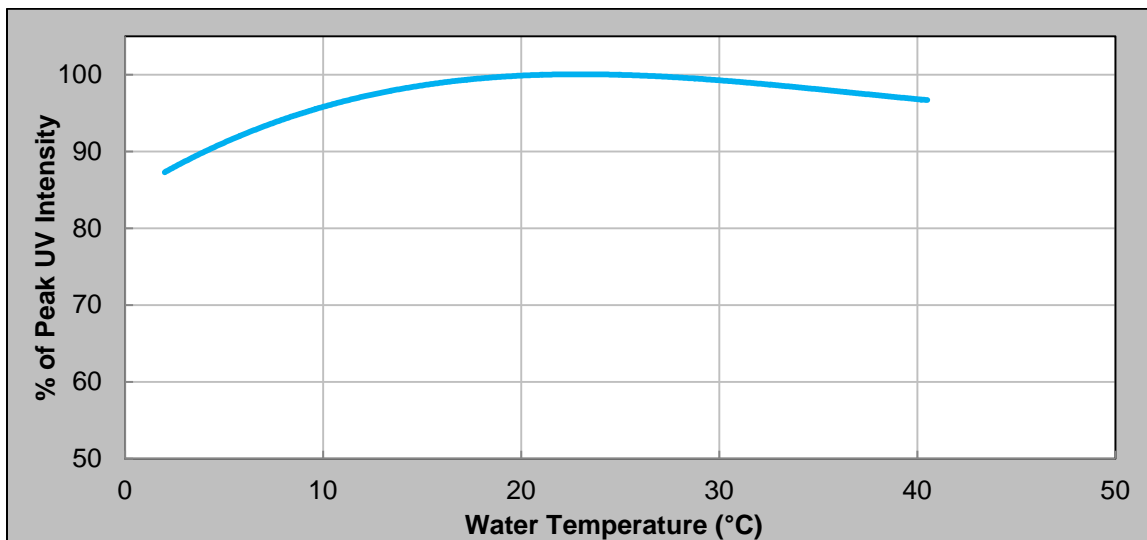

3.4.4 Quartz Sleeve

Each UV lamp is enclosed by a quartz sleeve made of GE Type 214 or equivalent clear fused silica quartz. Mineral deposits will form on the quartz, which inhibit the amount of light that can reach the water. The sleeve must be manually cleaned on a regular basis using a mineral acid such as a calcium, lime, and rust remover.

3.5 Product Features and Benefits

3.5.1 LightWise™ Technology

VIQUA's new LightWise™ technology allows the system's electronic controller to automatically reduce lamp power during periods of no water flow. In order to maintain dose levels above alarm setpoint values, the controller will dim to 62% power output. The dimming capability ultimately reduces the rate of sleeve fouling.

Benefits

- Lower maintenance; up to 60% less maintenance.
- Lower energy consumption; estimated savings of 30%.
- Lower operating temperature; maintained below 40°C in typical no flow conditions.
- Increased electrical efficiency minimizes carbon footprint.

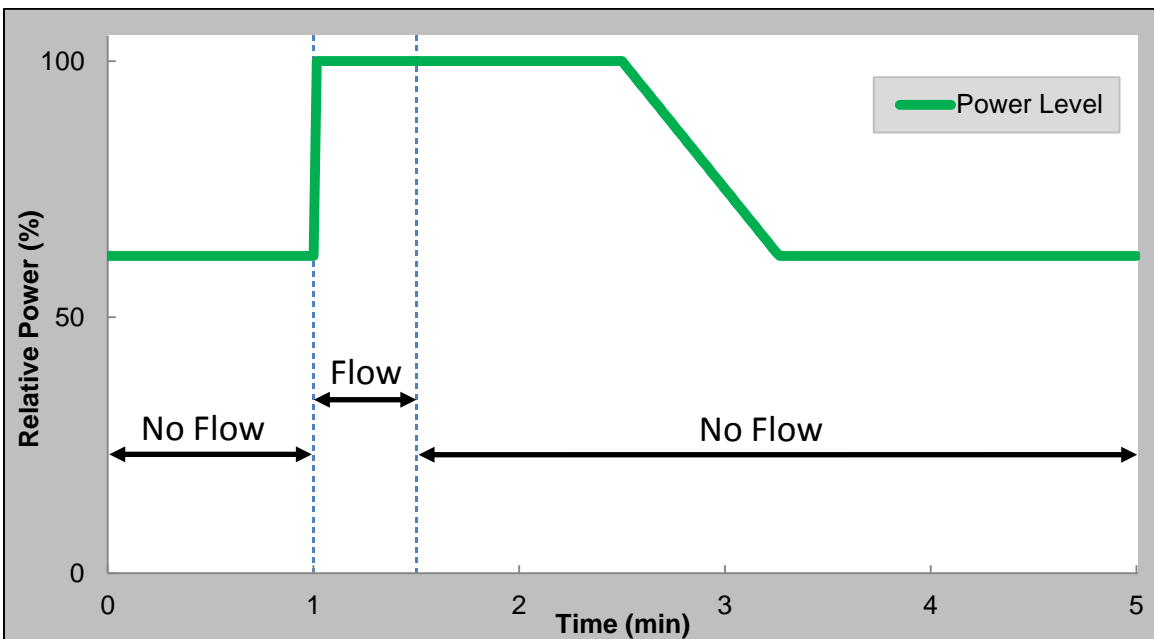

3.6 Signals and Remote Capabilities

3.6.1 Dry Contacts

The dry contact can be used to signal a remote device in event of the following major alarms:

- Lamp Fault
- Ballast (Controller) Fault
- UV Sensor Fault
- Low UV Fault



Connection Logic Chart

| Wire | Output Terminal | UV System in Normal Operation | UV System in Major alarm/not powered on |
|-------|--------------------------------|---|---|
| RED | N.O. (Normally Open Contact) | The Electrical path between these contacts are closed | The Electrical path between these contacts are open |
| BLACK | COM. (Common) | | |
| | COM. (Common) | The Electrical path between these contacts are open | The Electrical path between these contacts are closed |
| GREEN | N.C. (Normally Closed Contact) | | |

3.6.2 4-20 mA Interface

An optional 4-20 mA interface allows the user to read the current output by the UV sensor or the flow meter. The interface can be used to send information to other monitoring systems.



4.0 CERTIFICATIONS

All Adenovirus systems are tested and certified to USEPA UVDGM, UL, CE, RoHS, and Low Lead standards.



5.0 WARRANTY

VIQUA warrants the system components to be free from defects in material and workmanship for the time specified in the table below. During this time, VIQUA will repair or replace, at its option, any defective parts covered by the warranty.

| Component | Warranty |
|---|--|
| UV Chamber | ten (10) years from the date of purchase |
| Electrical (controller) and Hardware Components | five (5) years from the date of purchase |
| UV Lamps, Sleeves, and UV Sensors | one (1) year from the date of purchase |



VIQUA QUALITY PRINCIPLES

VIQUA is a sustainable business that designs and builds industry-leading UV systems. Our products are used worldwide in applications that help improve quality of life by disinfecting water using UV.

VIQUA utilizes quality materials and processes to ensure each product meets applicable user safety, disinfection, and environmental protection requirements. VIQUA's product development process ensures comprehensive product validation and certification.

VIQUA manufactures each UV disinfection system to very high quality standards. Each system is subjected to rigorous functional testing prior to shipment.

VIQUA is an ISO9001:2015 registered company.

425 Clair Rd. W, Guelph, Ontario, Canada N1L 1R1
Tel: (+1) 519-763-1032 • Toll Free: (+1) 800-265-7246 (US and Canada)
Tel: (+31) 73 747 0144 (Europe) • Fax: (+1) 519-763-5069
E-mail: info@viqua.com
www.viqua.com